

Optional equipment: Reclinable trellis jib 7.2 / 14 m

IDROGRU
CRANE

KT 200.40

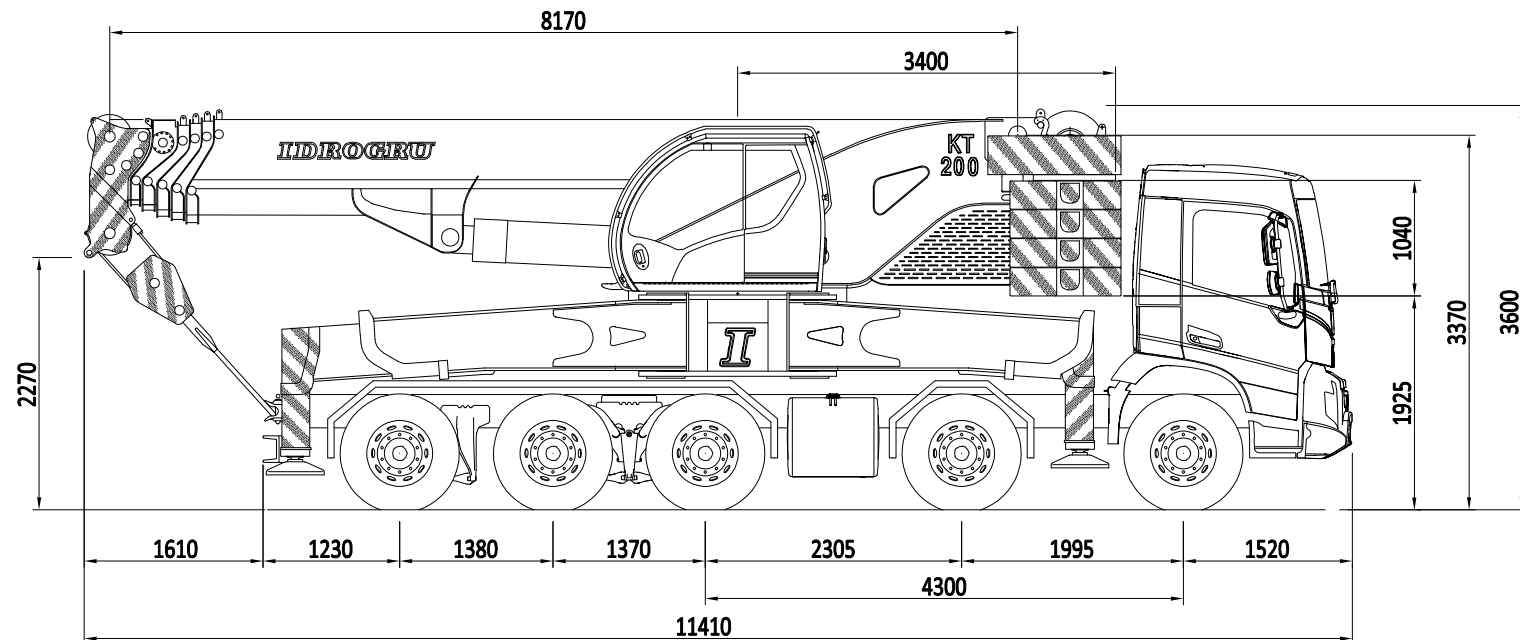
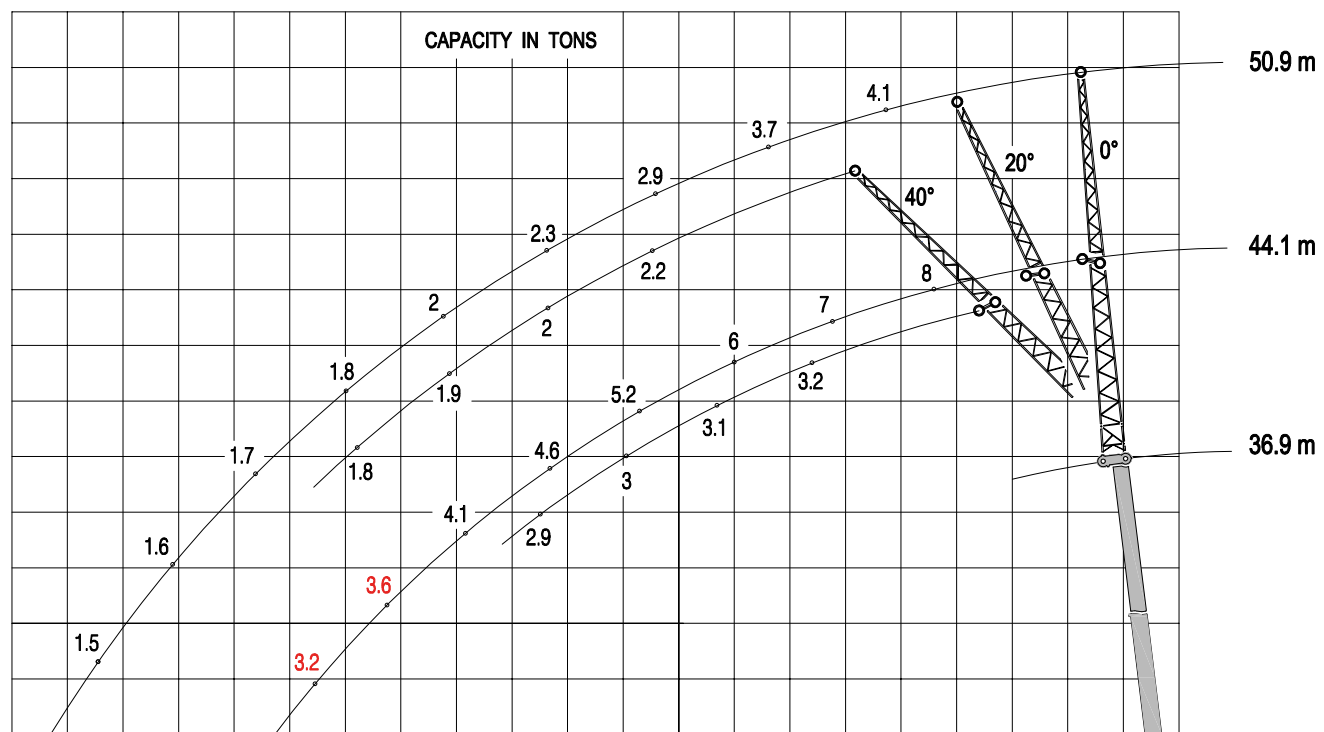

Divisible counterweight with automatic unloading

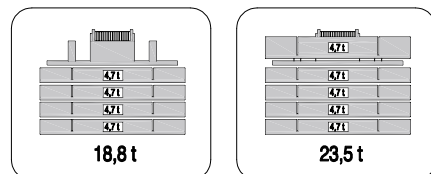
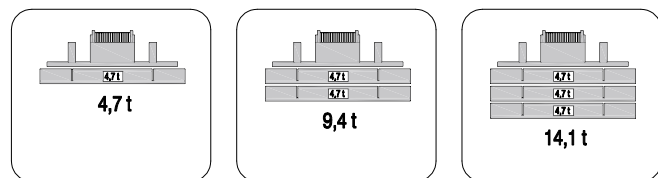

Three position reclinable boom head

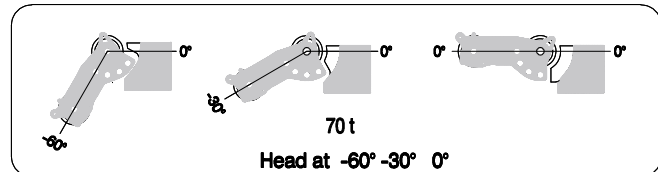

Primary winch

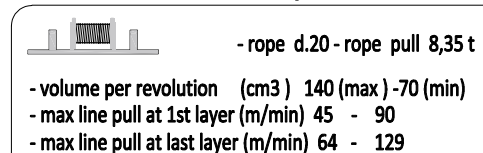

Double winch

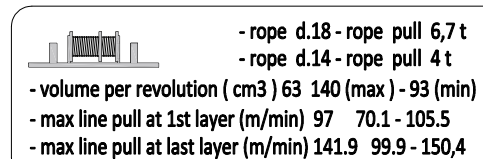

1,5 meters mechanic jib (for hook or pulley) with an extension of 1,5 meters.

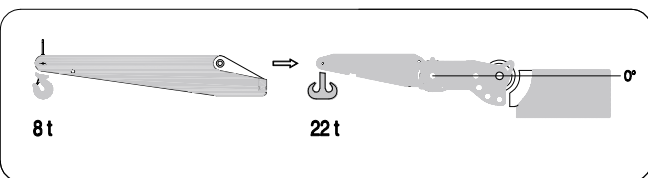

0,5 meters hook for reclinable boom head at -60° -30° 0°

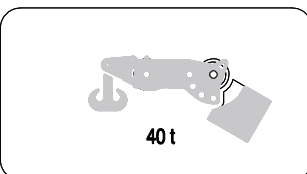

Hook blocks of various capacities

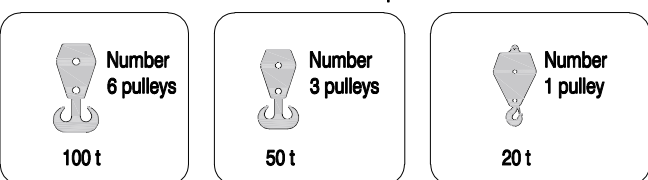

3 meters trellis jib

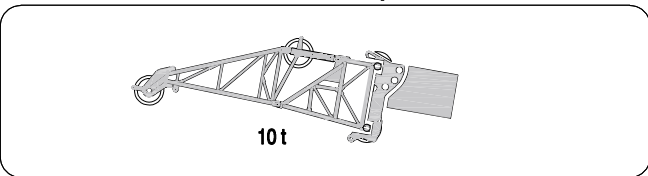

3,7 meters lift spreader beams

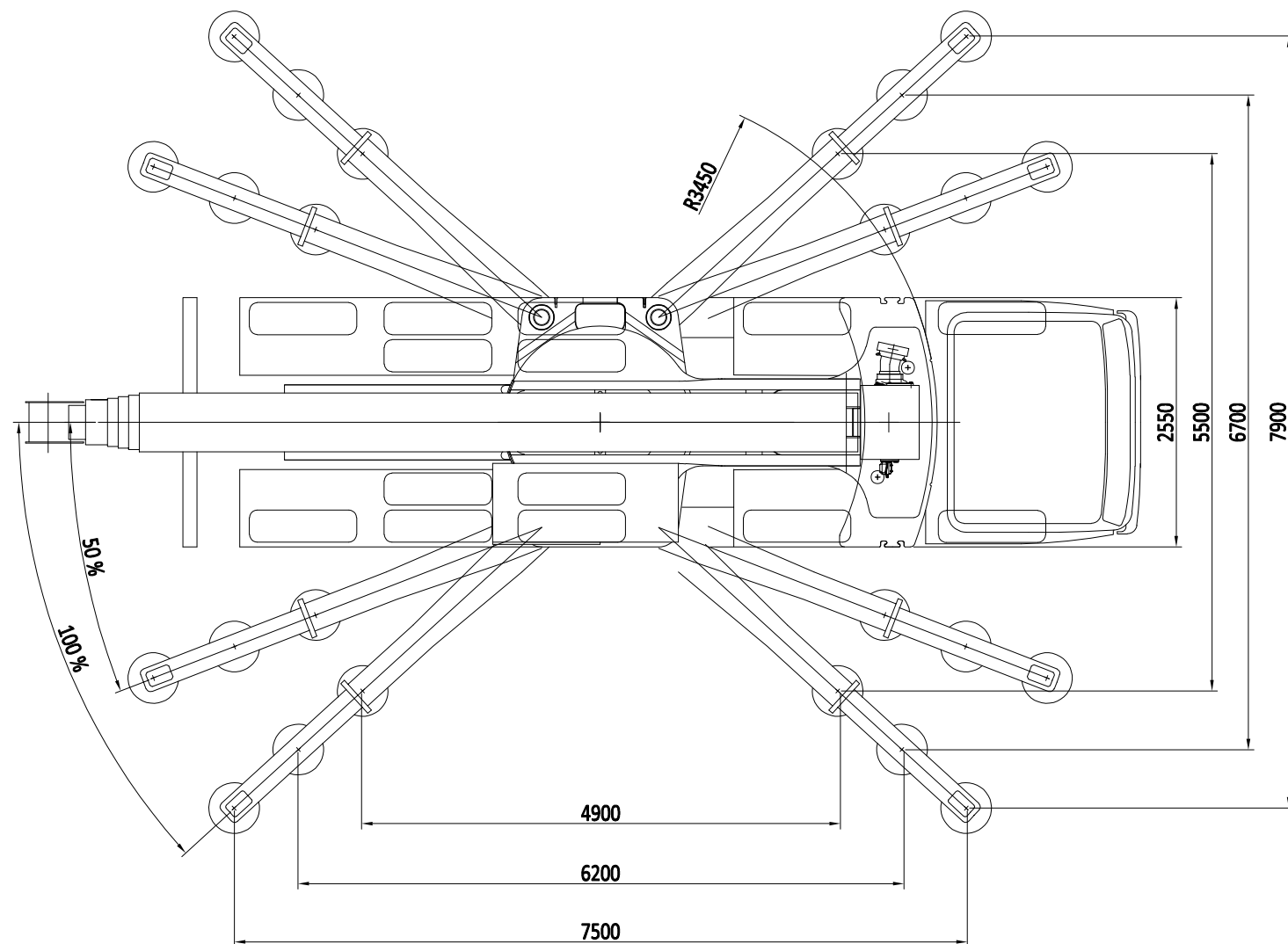
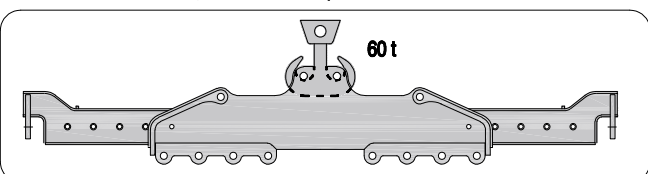

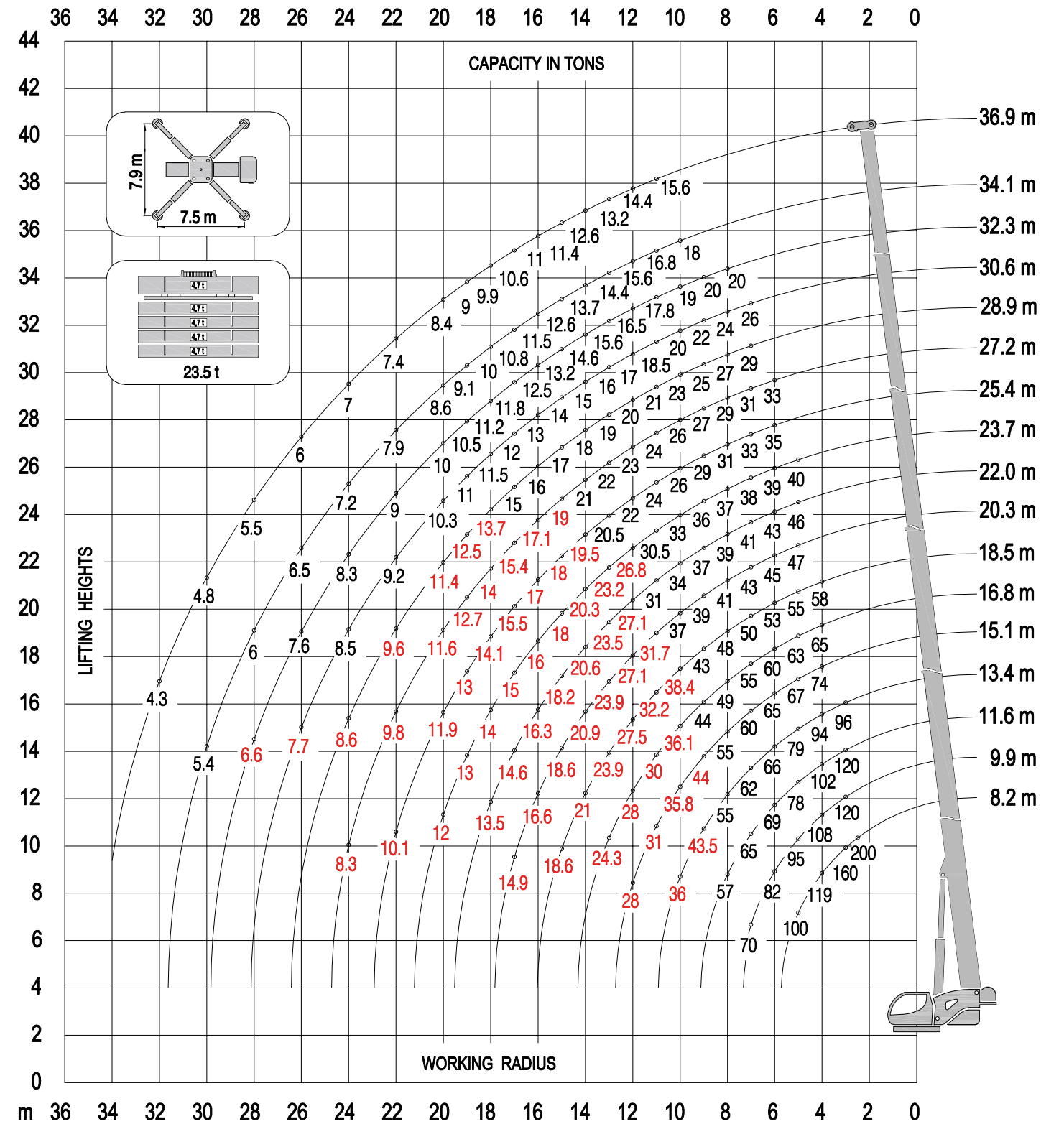
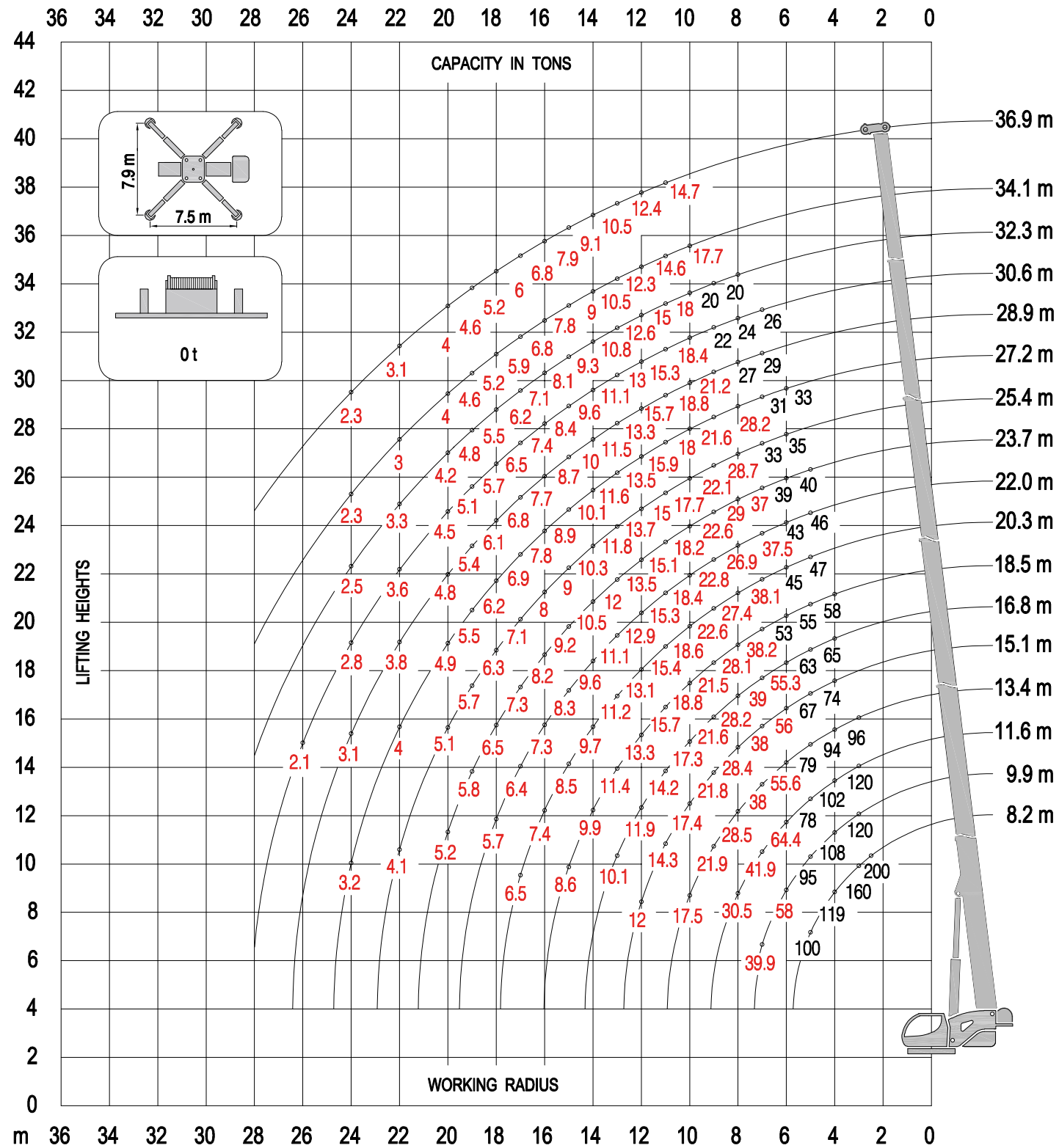

Max Payload: 100 t

The lifting capacities in the structural area are based on DIN 15018 part 3 / FEM 5.004 / EN 13000.
The lifting capacities in the stability area are based on DIN 15019 part 2 / ISO 4305 / EN 13000.