

**Optional equipment:**

Reclinable trellis jib 7.2 / 14 m

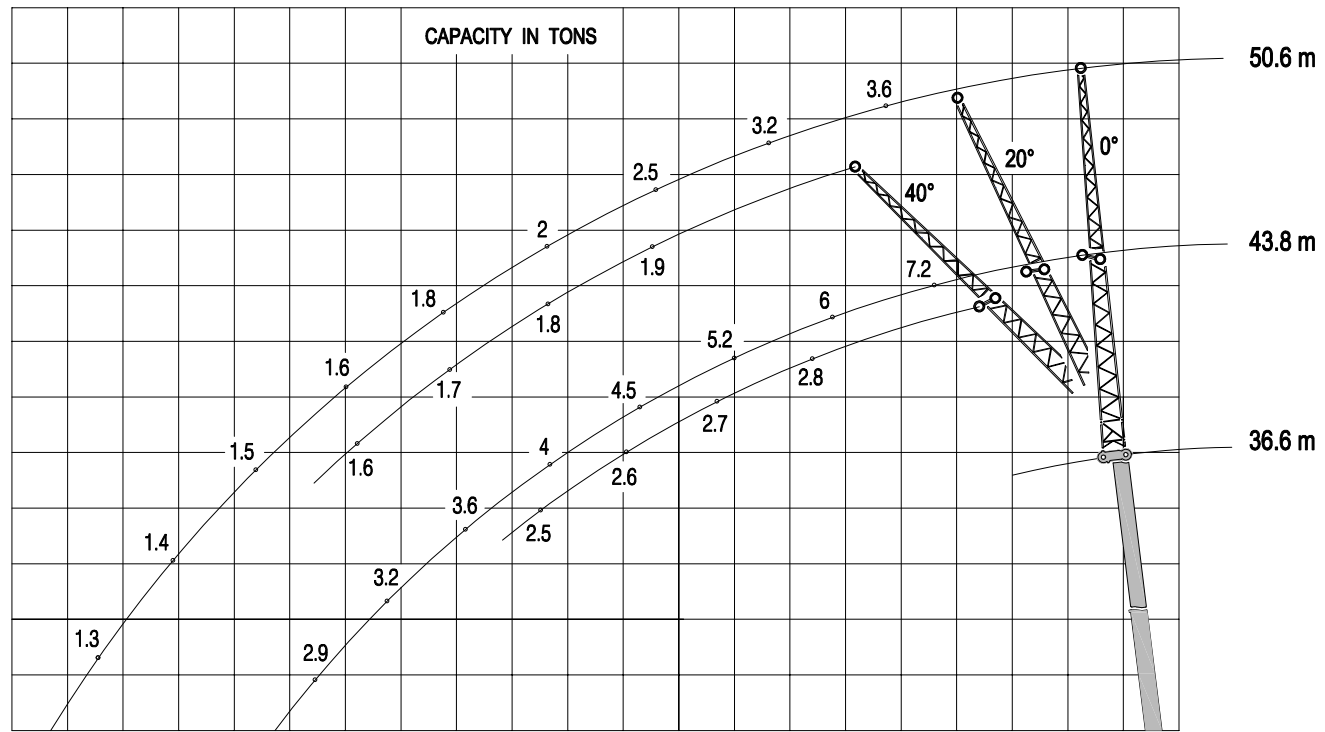

**IDROGRU**  
CRANE

**KT 160.40**

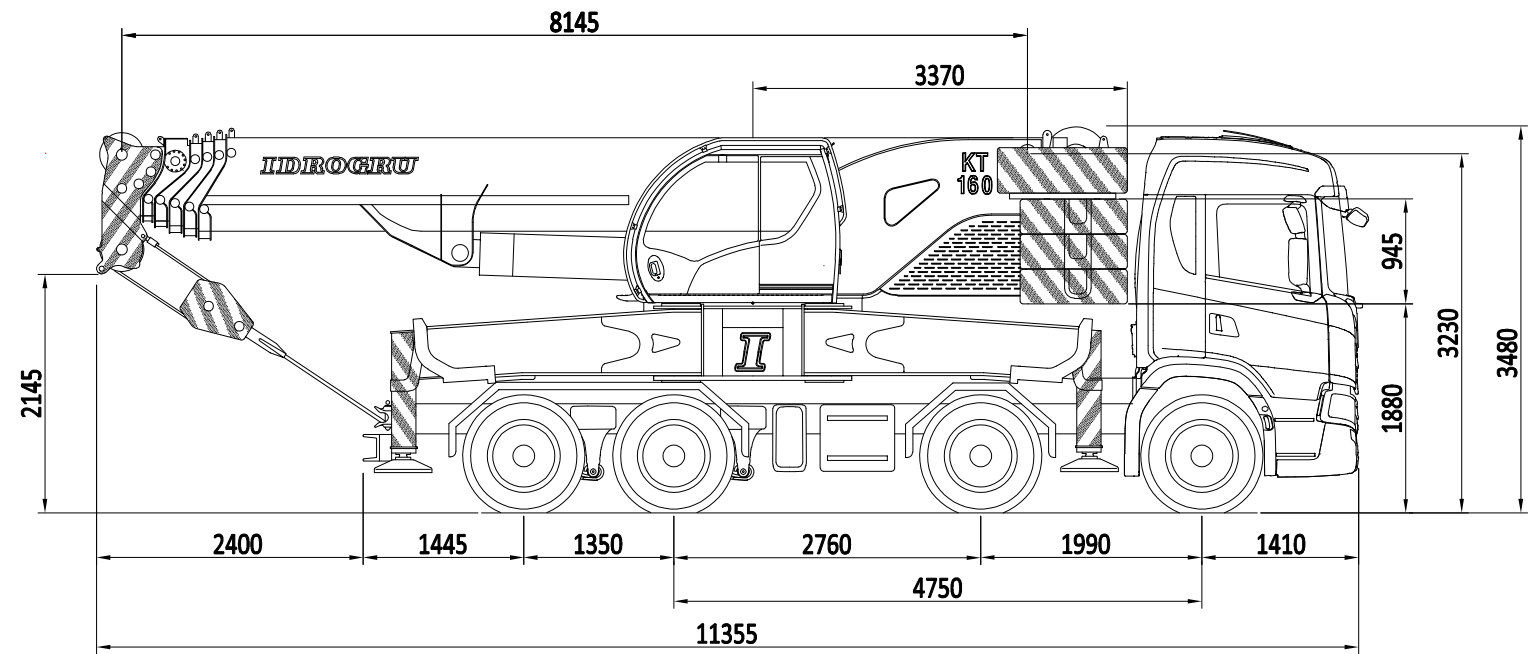

**Divisible counterweight with automatic unloading**

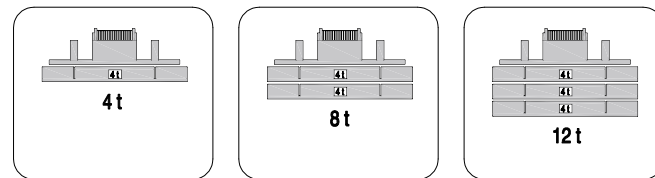

**1,5 meters mechanic jib (for hook or pulley) with an extension of 1,5 meters.**

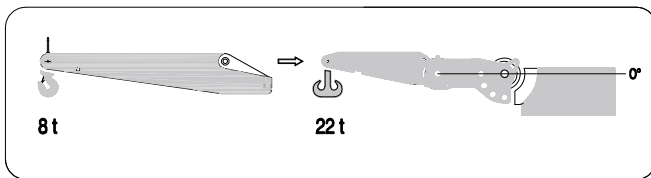

**0,5 meters hook for reclinable boom head at -60° -30° 0°**

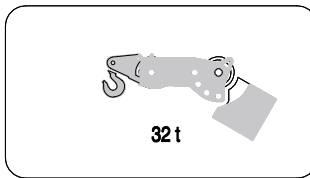

**Three position reclinable boom head**

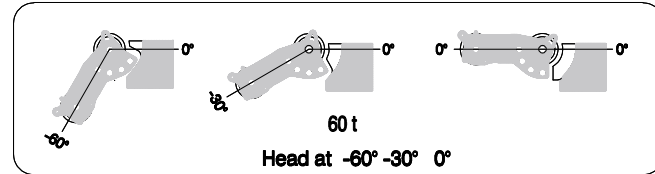

**Hook blocks of various capacities**

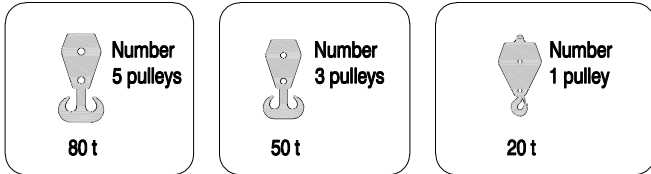

**Primary winch**

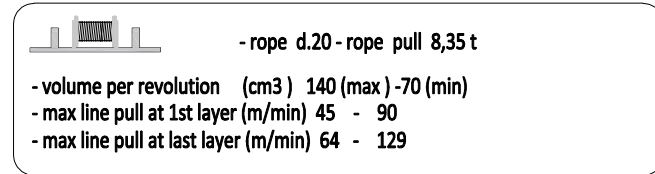

**3 meters trellis jib**

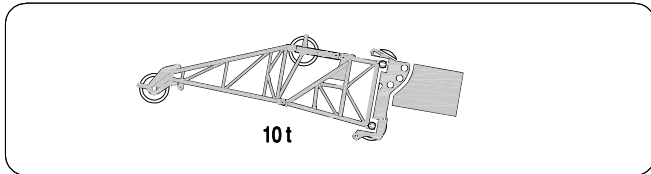

**Double winch**

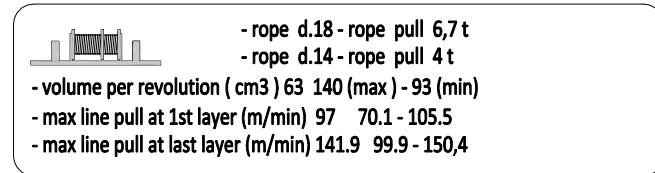

**3,7 meters lift spreader beams**

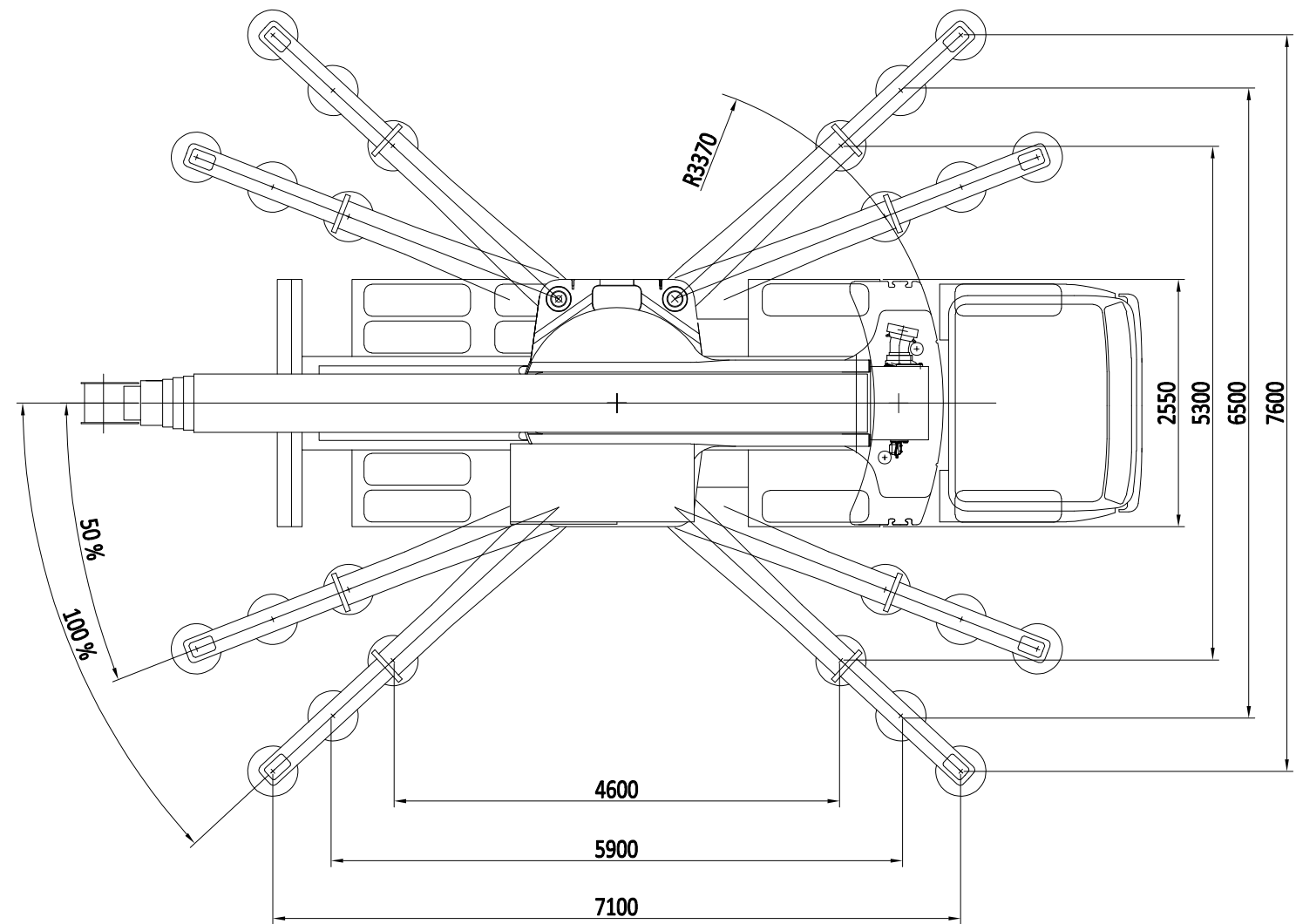
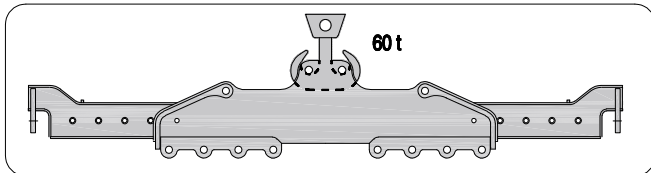

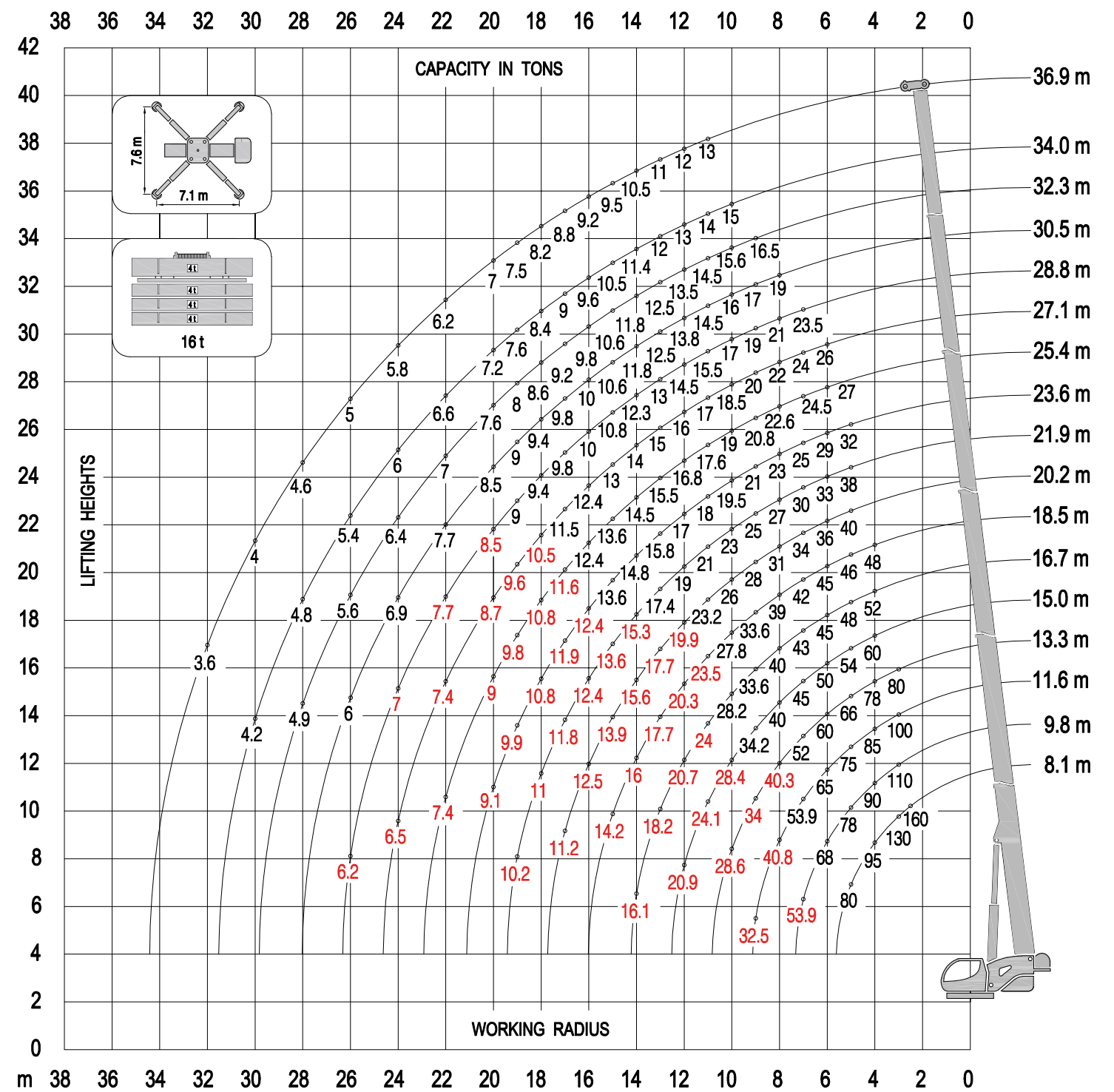
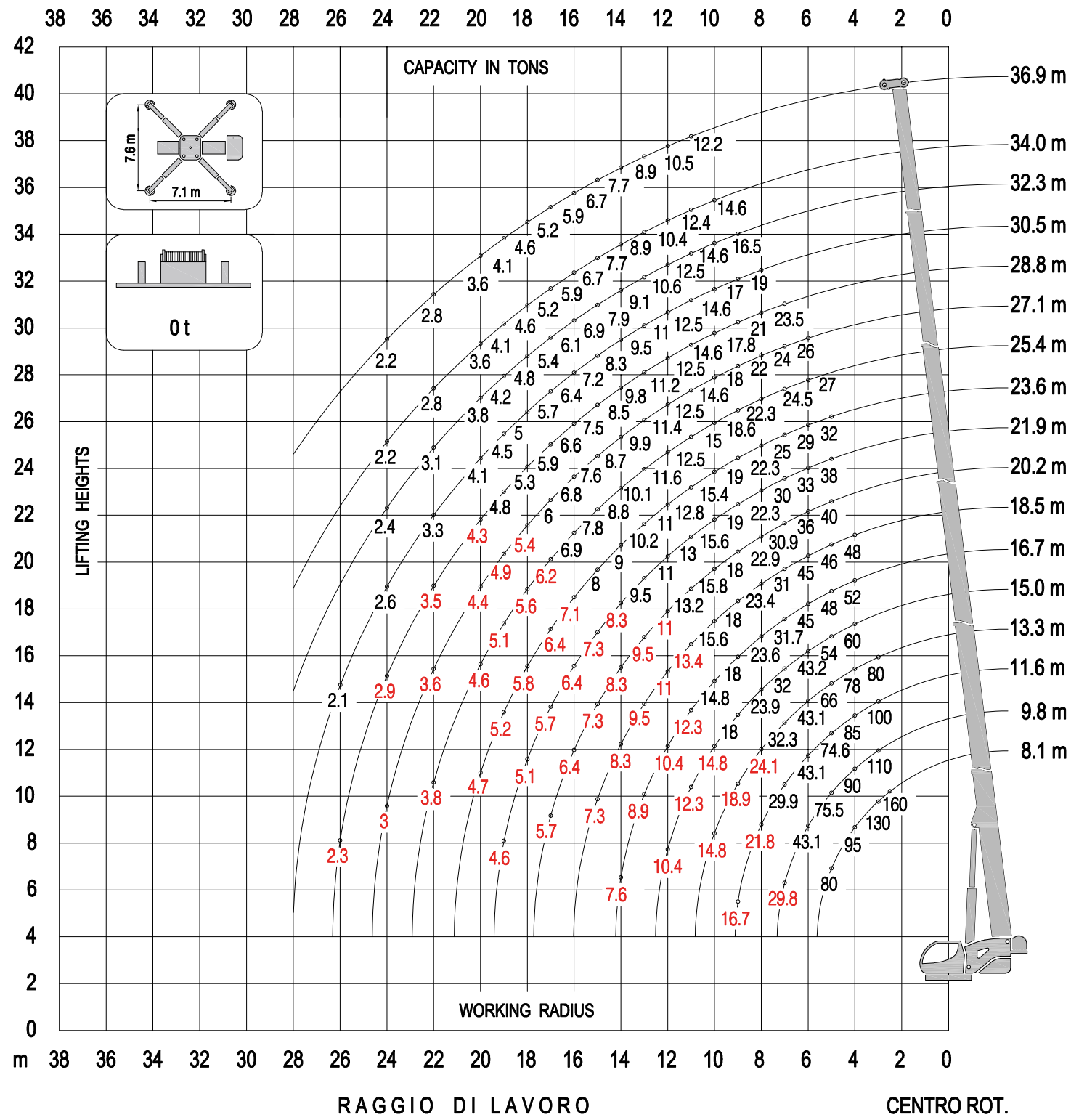

**Max Payload: 80 t**

The lifting capacities in the structural area are based on DIN 15018 part 3 / FEM 5.004 / EN 13000.  
The lifting capacities in the stability area are based on DIN 15019 part 2 / ISO 4305 / EN 13000.